

This Box Contains These Parts:

WARNING For safety, remove all collars and leashes before allowing pet to enter any cage.

OUTBACK Log Cabin™

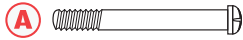

6mm x 55mm Bolt (8pcs)



6mm x 55mm Nut (8pcs)



3.5mm x 45mm Screw (4pcs)



3.5mm x 30mm Screw (8pcs)

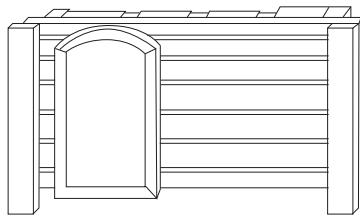

Front Panel

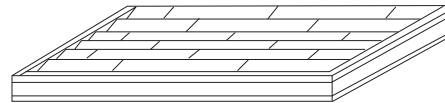

Roof Panel

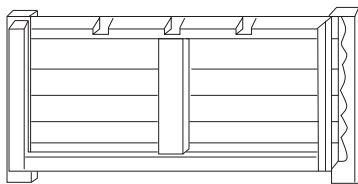

Back Panel

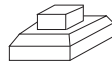

Legs x4

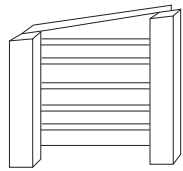

Side Panel x2

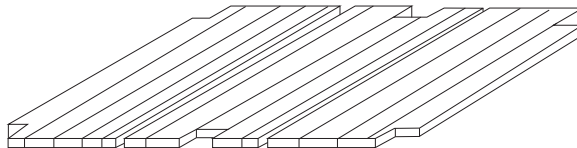

Floor Panel x3

Assembly Instructions *Screwdriver Needed for Assembly

Attach Front & Back Panels to Side Panels

Required Components

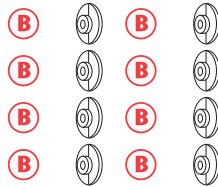

6mm x 55mm Nut

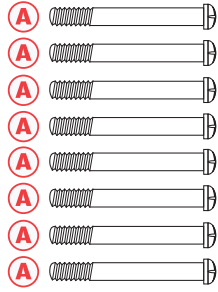

6mm x 55mm Bolt

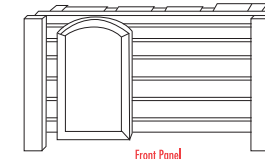

Front Panel

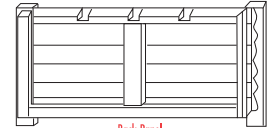

Back Panel

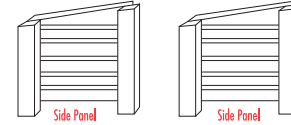

Side Panel

Side Panel

STEP 1

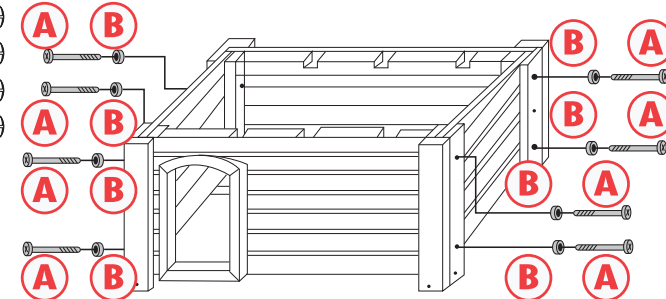

Attach Feet

Required Components

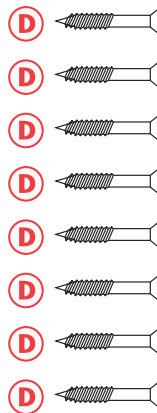

3.5mm x 30mm Screw

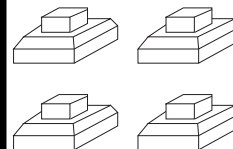

Legs

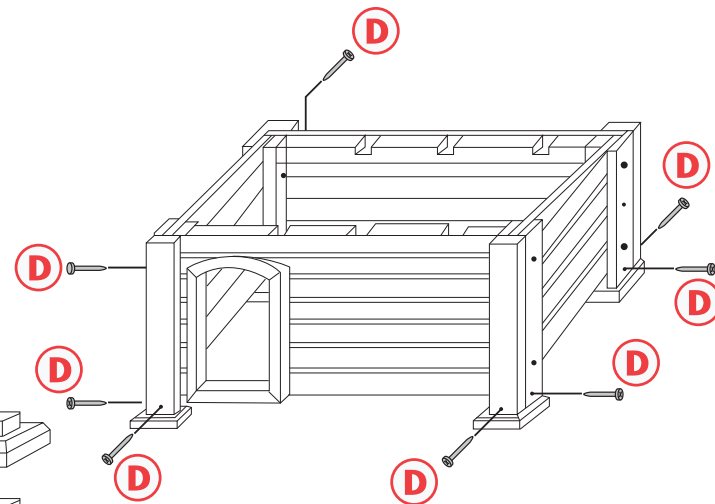

building instruction

Drop in Floor Required Components

STEP 2

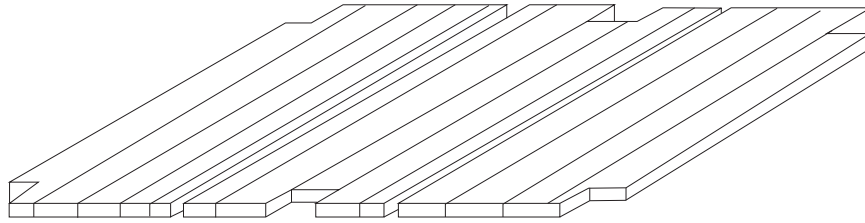

Floor Panel x3

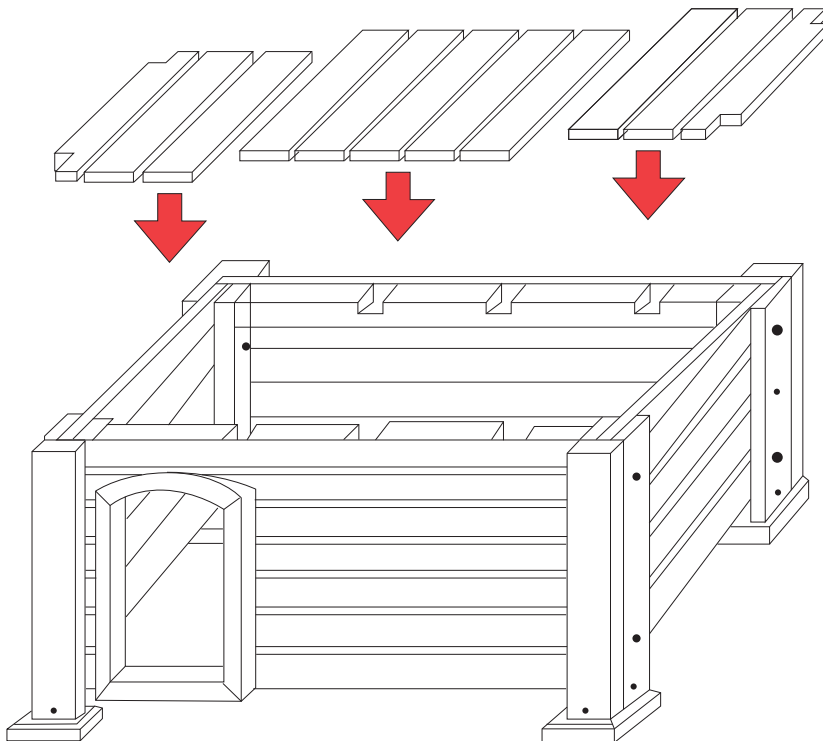

Attach Roof Required Components

STEP 3

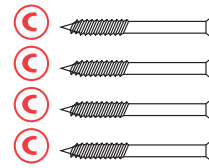

3.5mm x 45mm Screws

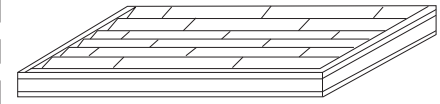

Roof Panel

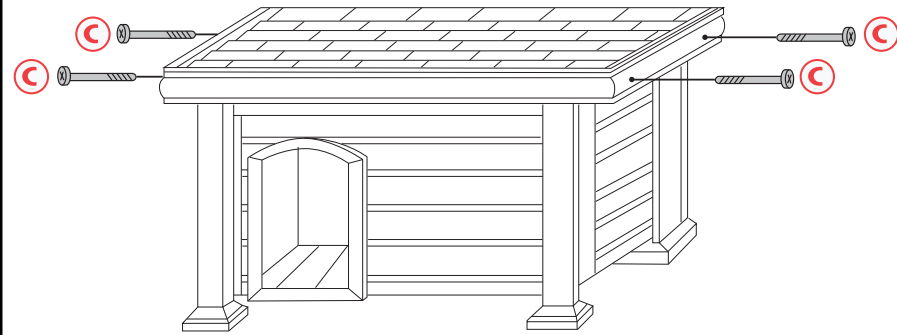

Floors may be removed through door after roof is attached.

Completed Assembly

STEP 4

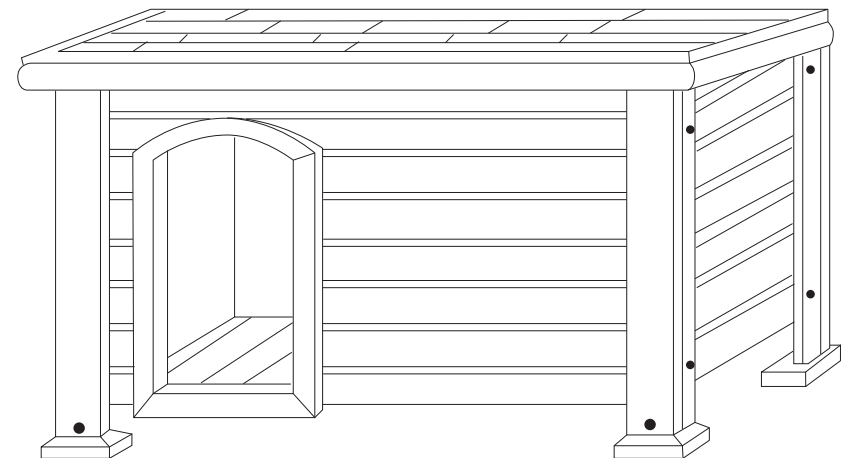

building
instruction